

# InCos-P Pressure sensor 20 Pa ... 7.500 Pa

Electrical pressure/differential pressure sensors  
24 VAC/DC supply voltage, 0...10 V/(0)4...20 mA analogue output

InCos - P- ...
InCos - P- ... - A
InCos - ... - CT
InCos - ... - OCT
InCos - ... - VA
InCos - ... - OVA

Subject to change!

**Compact. Easy installation. Universal. Cost effective. Safe.**

Type	Sensor	Supply	Range	min. Setting	max. Pressure	Output	2nd output	Wiring diagram	
InCos- P- 100	Pressure/Diff. press.	24 VAC/DC	± 100 Pa	20 Pa	25.000 Pa	(0)4...20 mA / 0...10 V	–	SB 1.0	
InCos- P- 250	Pressure/Diff. press.	24 VAC/DC	± 250 Pa	50 Pa	25.000 Pa	(0)4...20 mA / 0...10 V	–	SB 1.0	
InCos- P- 500	Pressure/Diff. press.	24 VAC/DC	± 500 Pa	100 Pa	50.000 Pa	(0)4...20 mA / 0...10 V	–	SB 1.0	
InCos- P-1250	Pressure/Diff. press.	24 VAC/DC	± 1.250 Pa	250 Pa	50.000 Pa	(0)4...20 mA / 0...10 V	–	SB 1.0	
InCos- P-2500	Pressure/Diff. press.	24 VAC/DC	± 2.500 Pa	500 Pa	50.000 Pa	(0)4...20 mA / 0...10 V	–	SB 1.0	
InCos- P-5000	Pressure/Diff. press.	24 VAC/DC	± 5.000 Pa	1.000 Pa	75.000 Pa	(0)4...20 mA / 0...10 V	–	SB 1.0	
InCos- P-7500	Pressure/Diff. press.	24 VAC/DC	± 7.500 Pa	1.500 Pa	120.000 Pa	(0)4...20 mA / 0...10 V	–	SB 1.0	
InCos- P- ... - A	Types as above with additional analogue output to connect an external digital indicator							(0)4...20 mA	SB 3.1
InCos- P- ... - CT	Types as above with aluminium housing and seawater resistant coating (cable glands M16 brass nickel-plated, screws in stainless steel)								
InCos- P- ... - OCT	Types as above, offshore version with aluminium housing and seawater resistant coating (stainless steel tubes for clamping ring connection, cable glands M20 brass nickel-plated, screws in stainless steel)								
InCos- P- ... - VA	Types as above with stainless steel housing for aggressive ambient (cable glands M20 brass nickel-plated, screws in stainless steel)								
InCos- P- ... - OVA	Types as above, offshore version with stainless steel housing for aggressive ambient (tubes for clamping ring connection and screws in stainless steel, cable glands M20 brass nickel-plated)								

## Product views and applications



### Description

The InCos-P... pressure sensor generation from ± 100 Pa to ± 7.500 Pa (acc. to type) is a revolution for differential pressure measuring in HVAC systems, in chemical, pharmaceutical, industrial and offshore/onshore plants.

IP66 protection, small dimensions, universal functions and technical data guarantee safe operation even under difficult environmental conditions. All sensors are programmable on site without any additional tools. The measuring ranges are scalable within the maximum ranges. At ...Cos-P-100 the smallest ΔP range is 20 Pa. The analogue output signal is either 0...10 VDC or (0)4...20 mA and can be selected on site. The integrated display is for parametrisation and an actual value indication at working mode (can be switched off as needed).

...Cos-P...-A sensors are equipped with an additional output, e.g. for an external indicator.

...Cos-P...-OCT and ...-OVA offshore versions are equipped with stainless steel tubing Ø 6 mm.

### Highlights

- ▶ For industrial use
- ▶ Power supply 24 VAC/DC
- ▶ Scalable analogue output, selectable 0...10 V / (0)4...20 mA
- ▶ Integrated terminal box
- ▶ Optional output (0)4...20 mA for external indicator
- ▶ Display with backlight, can be switched off
- ▶ Password locking
- ▶ Down to -20 °C ambient temperature applicable
- ▶ Compact design and small dimension
- ▶ Robust aluminium housing (optional with seawater resistant coating) or in stainless steel
- ▶ IP66 protection
- ▶ Offshore versions with pressure tube connection for clamping ring Ø 6 mm

### Technical data

Supply voltage, frequency	24 VAC/DC $\pm 20\%$ (19,2...28,8 VAC/DC), 50/60 Hz
Current, power consumption	150 mA, ~ 4 W, internal fuse 500 mA, without bracket, not removable
Galvanic isolation	Supply for analogue in- and outputs min. 1,5 kV, supply for relay output min. 1,5 kV
Electrical connection	Terminals 0,14...2,5 mm <sup>2</sup> at integrated terminal box, stripping length 9 mm, torque 0,4...0,5 Nm, equipotential bonding 4 mm <sup>2</sup>
Cable glands	2 x M16 x 1,5 mm, for cable diameter ~ $\varnothing$ 5...9 mm
Cable glands ...-CT	2 x M16 x 1,5 mm, brass nickel-plated, for cable diameter ~ $\varnothing$ 6...10 mm
...-VA, ...-OCT, ...-OVA	2 x M20 x 1,5 mm, brass nickel-plated, for cable diameter ~ $\varnothing$ 6...13 mm
Protection class	Class I (grounded)
Display	2 x 16 digits, dot-matrix display, backlit, for configuration, user guidance, parameter and actual value indication
Control elements	3 buttons for configuration
Housing material	Aluminium die-cast housing, coated. Optional with seawater resistant coating (...-CT/...-OCT) or stainless steel housing, № 1.4581 / UNS-J92900 / similar AISI 316Nb (...-VA/...-OVA)
Dimensions (L x W x H)	Aluminium housing ~ 180 x 107 x 66 mm, stainless steel housing ~ 195 x 127 x 70 mm (each without connectors)
Weight	~ 950 g aluminium housing, stainless steel version ~ 2,5 kg
Ambient temperature	-20...+50 °C, storage temperature -35...+70 °C
Ambient humidity	0...95 % rH, non condensing
Sensor circuit	Internal circuit
Sensor	Piezo pressure transmitter
Pressure connection	P+ / P- sleeves $\varnothing$ 4...6 mm. OCT versions have 2 stainless steel (316L) tube connections for clamp ring fittings $\varnothing$ 6 mm
Measuring range	$\pm 100$ Pa, $\pm 250$ Pa, $\pm 500$ Pa, $\pm 1.250$ Pa, $\pm 2.500$ Pa, $\pm 5.000$ Pa, $\pm 7.500$ Pa in acc. to type Minimum measuring range is 20 % of full range (e.g. 20 Pa at $\pm 100$ Pa sensor)
Response time of sensor	T90 / 5 s
Accuracy of pressure	< $\pm 1\%$ typically, max. $\pm 2\%$ of end value $\pm 1$ Pa
Non linearity and hysteresis	$\pm 0,05\%$ typically, max. 0,25 % of end value
Start delay	5 s
Setting zero point	Via menu. Short-circuit mechanically both tube connectors P+ / P- for the moment of zero point setting
Stability	Long term stability < 0,2 %/year, temperature influence < 0,02 %/K, supply voltage influence < 0,01 %
Output	Voltage U [V] or current I [mA], selectable on site via menu, protected against short circuit and external voltage up to 24 V and against polarity reversal
Voltage output U	0...10 VDC adjustable, invertible, burden > 1 k $\Omega$ , influence < 0,05 %/100 $\Omega$
Current output I	0...20 mA adjustable, invertible, burden < 500 $\Omega$ , influence < 0,1 %/100 $\Omega$ , open circuit voltage < 24 V
Output in alarm mode	Increasing or decreasing output signal, selectable on site, down to 0 VDC/0 mA or up to 10 VDC/20 mA
Wiring diagram	SB 1.0
Scope of delivery	Sensor, 3 self-tapping screws 4,2 x 13 mm resp. in stainless steel (with ...CT and ...VA versions), short circuit tube Cos-P...-A with 1 additional plug for cable $\varnothing$ 6...8 mm
Parameter at delivery	min./max. pressure range limits (e.g. InCos-P-100 = -100...+100 Pa), output 4...20 mA, output in alarm mode decreasing to 0 V/0 mA
...Cos-P...-A	as above and 1 additional analogue output
Analogue output	(0)4...20 mA, burden max. 400 $\Omega$
Accuracy	$\pm 0,5\%$
Wiring diagram	SB 3.1

### Approbations

CE identification	CE
EMC directive	2014/30/EU
Enclosure protection	IP66 in acc. with EN 60529
EAC	TC N RU Д-DE.AB45.B.58607

### Special solutions and accessories

...-CT	Types in aluminium housing with seawater resistant coating, parts nickel-plated
...-OCT	Offshore version in aluminium housing with seawater resistant coating, parts nickel-plated
...-VA	Types in stainless steel housing, parts nickel-plated
...-OVA	Offshore version in stainless steel housing, parts nickel-plated
NOC-RIA-16	LCD indicator for InCos-... sensors in safe areas
MKR	Mounting bracket for round ducts up to $\varnothing$ 600 mm
Kit 2	Flexible pressure tube, 2 m, inner $\varnothing$ 6 mm, 2 connection nipples
Kit-S8-CBR	2 cable glands M16 x 1,5 mm, Ex-e, brass nickel-plated, for cable $\varnothing$ 5...10 mm
Kit-Offs-GL-CBR	2 cable glands M20 x 1,5 mm, Ex-d, Ms-Ni, for armoured cables
Kit-PTC-CBR	2 connecting tubes for tube fittings $\varnothing$ 6 mm, stainless steel 316 L

### Electrical connection

All sensors require a 24 VAC/DC power supply. The electrical wiring must be realized via the integrated terminal box.

**Attention:** Before opening the terminal box cover, the supply voltage must be shut off! The supply has to be connected at terminals 1 (-/~) and 2 (+/~), the analogue output at terminals 3 (mA/V) and 4 (GND).

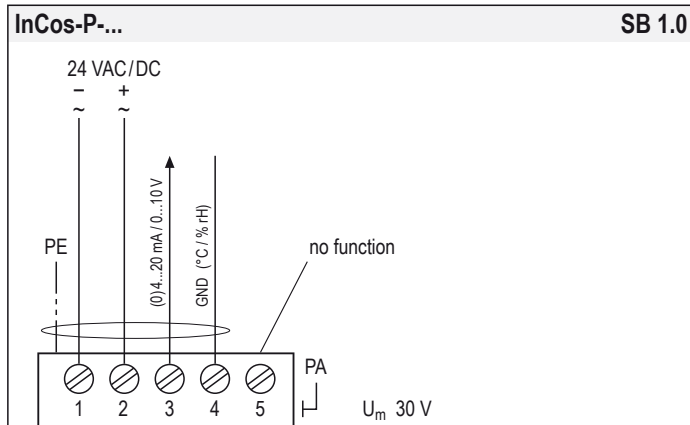

### Electric characteristics – Internal pressure sensor

$U_{max}$  5.5 V

Internal sensor values are corresponding to the internal pressure sensor. Due to the matter of fact that there is no external sensor connected, these values are not relevant for the customer but shown for the sake of completeness.

### Output (optional) – InCos-P-...-A

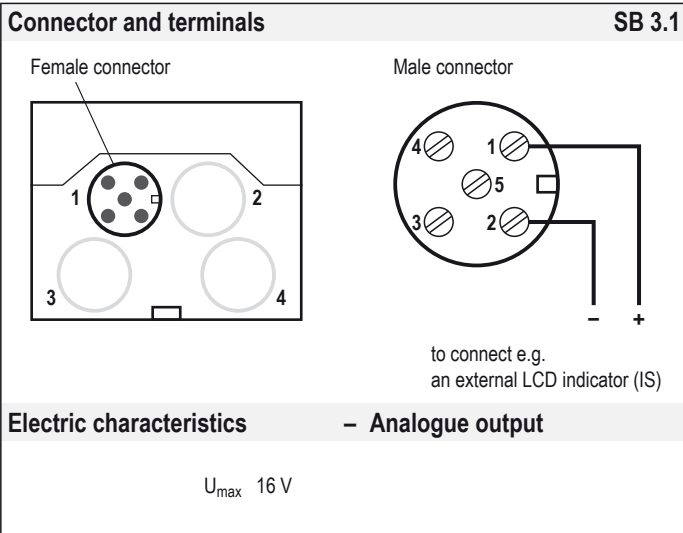

### Electric characteristics – Analogue output

$U_{max}$  16 V

### Zero point compensation

...Cos-P-... pressure sensors are equipped with a zero point compensation to adjust the module to the installation position. The pressure nipples P+ / P- must be connected with a short circuit tube and the zero point compensation performed by following the menu for parametrisation (menu 18).

Before starting the zero point compensation, the device should be connected to power supply for a minimum of 15 minutes to reach the uniform working temperature!

### Display, buttons and parameters

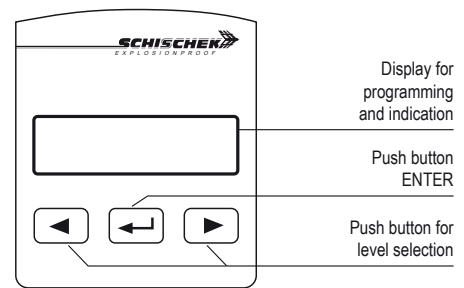

#### Change operation – parametrisation mode

To change from operation to parametrisation mode and vice versa, push  ENTER button for minimum of 3 seconds. Back to operation mode with menu "save".

#### Indication of data logging

A flashing star in the display shows that data is received and the device is working.

#### Password input

The default/delivery setup is 0000. In this configuration the password input is not activated. To activate the password protection (menu 20) change the 4 digits into your chosen numbers (e.g. 1234) and press ENTER.

Please keep your password in mind for next parameter change! Due to a new parameter setup the password is requested.

### Important information for installation and operation

#### A. Installation, commissioning, maintenance

All national and international standards, rules and regulations must be complied with. Apparatus must be installed in accordance with manufacturer instructions. If the equipment is used in a manner not specified by the manufacturer, the safety protection provided by the equipment may be impaired.



**Attention:** Apply all protective rules and regulation before opening the internal terminal box. Do not open cover when circuits are live!

Draw the wiring cables through the cable glands. For connection use the internal terminal box and connect equipotential bonding.

After connection install the cables in a fixed position and protect them against mechanical and thermal damage. Close all openings and ensure IP protection (min. IP66).

Avoid temperature transfer and ensure not to exceed max. ambient temperature! For outdoor installation a protective shield against sun, rain and snow should be applied. After mounting and installation a zero point compensation must be done to ensure correct measurement results (see description).

Sensors are maintenance free. An annual inspection is recommended. Clean with damp cloth only.

Sensors must not be opened and repaired by the end user.

#### B. Long cabling

We recommend using shielded signal wires and to connect one end of the shield to the ...Cos-... terminal box.

#### C. Separate ground wires

For supply and signal wires use separate grounds.

### Parametrisation and commissioning

To change from operation to parametrisation mode push the "ENTER" button (↵) for minimum 3 seconds.  
If password protected: type password and push (↵).  
Back over to menu "Save" and exit.

Operation → Parametrisation  
push (↵) for min. 3 s

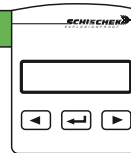

**Example:** Menu language English  
Range -25...+25 Pa  
Output 4...20 mA  
2nd output 0...20 mA

Menu	Function	ENTER	Indication	Select	ENTER	Next indication	Select	ENTER	Next menu
Menu 1	<b>DE, EN, FR</b> Select language: German, English, French	(↵)	DE, EN, FR English	(←) (→)	(↵)				(→)
Menu 2	no function – menu skip		Deutsch, English, Francais						
Menu 3	no function – menu skip								
Menu 4	<b>Unit sensor</b> Select physical unit	(↵)	unit sensor Pa	(←) (→)	(↵)				(→)
Menu 5	<b>Range</b> Adjust the measuring range	(↵)	range -25...100 Pa	(←) (→)	(↵)	range -25...25 Pa	(←) (→)	(↵)	(→)
Menu 6	no function – menu skip		← adjust lower limit			← adjust higher limit			
Menu 7	<b>Output V, mA</b> Select output signal as V or mA		output V/mA mA	(←) (→)	(↵)				(→)
Menu 8	<b>Output range</b> Adjust output range		output range 4...20 mA	(←) (→)	(↵)	output range 4...20 mA	(←) (→)	(↵)	(→)
Menu 9	<b>Sensor error</b> Select signal at sensor error		sensor error 10 V/20 mA	(←) (→)	(↵)				(→)
Menu 10	<b>Output ↕</b> Select signal output behaviour		output ↕ increasing	(←) (→)	(↵)				(→)
Menu 11	no function – menu skip		↕ increasing, decreasing						
Menu 12	no function – menu skip								
Menu 13	no function – menu skip								
Menu 14	no function – menu skip								
Menu 15	no function – menu skip								
Menu 16	<b>Add. output (option, only at ...Cos-P...-A)</b> Select lower output signal: 0 mA resp. 4 mA (0...20 or 4...20 mA)	(↵)	output 0...20 mA	(←) (→)	(↵)	output 0...20 mA	(←) (→)	(↵)	(→)
Menu 17	no function – menu skip		← adjust lower limit			← adjust higher limit			
Menu 18	<b>Zero point compensation</b> After short circuit the pressure nipples P+/P- the sensor gets a zero point calibration		set zero point yes no	(←) (→)	(↵)				(→)
Menu 19	<b>Display function</b> Select display settings	(↵)	display function on illuminated	(←) (→)	(↵)				(→)
Menu 20	<b>Password</b> Select password protection	(↵)	new password yes no	(←) (→)	(↵)	password 0000	(←) (→)	(↵)	(→)
Menu 21	<b>Save and exit</b> Select: save data, factory setting, discard or back to menu	(↵)	save and exit save data	(←) (→)	(↵)				(→)
Menu 22	<b>Set offset</b> Add/subtract offset from measure value	(↵)	set offset 0.00 Pa	(←) (→)	(↵)				(→)
Menu 23	no function – menu skip								
Menu 24	<b>Attenuation</b> Damping the output signal (signal filter)	(↵)	attenuation 0	(←) (→)	(↵)				(→)

**Dimensions [mm]**

Aluminium housing

...Cos-P...-OCT

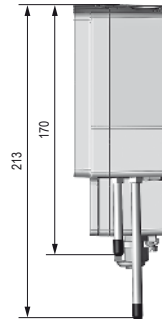
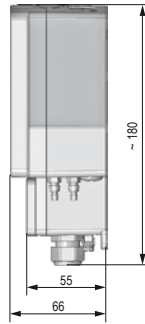
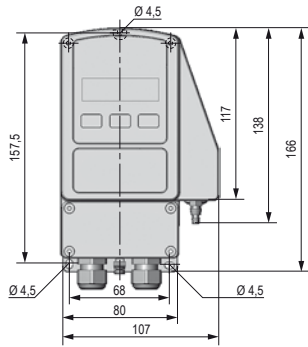

Stainless steel housing

...Cos-P...-OVA

